

# CM/CME

## COMPACT PUMPS FOR DEMANDING APPLICATIONS





# COMPACT, FLEXIBLE, RELIABLE SOLUTIONS FOR TIGHT SPACES

Grundfos Centrifugal Modular (CM) pumps are the most compact on the market. CM/CME pumps work as built-in pumps in OEM solutions and are the optimal solution for installation and interaction with other components in a larger product.

With interchangeable modules and compact design, these horizontal multistage pumps are ideal for use in a wide variety of applications such as:



Washing and cleaning

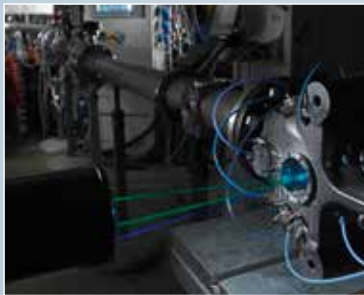

Temperature control



Chemical and  
Pharmaceutical industries



Pressure boosting



CM stainless steel



CM  
cast iron



CM selfpriming



## PERFORMANCE CURVES

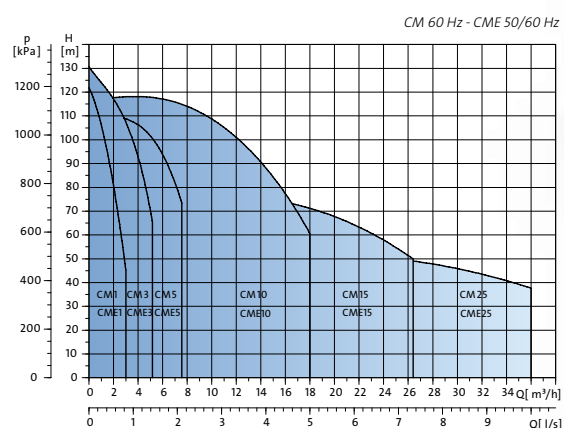
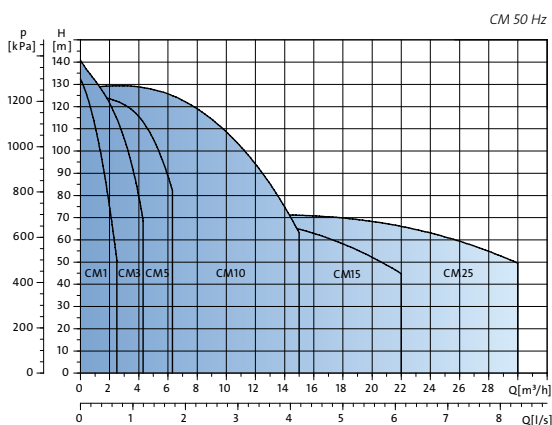

# CM/CME PUMPS OFFER RELIABLE PERFORMANCE AND A RANGE OF FEATURES:

- Wide temperature range: from -30C to 120C
- Low maintenance and spare parts costs
- Robust and reliable design
- Mechanical shaft seals
- Flexible range of connections to fit end-user's solution
- Quiet operation
- Choose between a range of materials to suit your application: cast iron; AISI 304/DIN 1.4301 Stainless Steel; AISI 316/ DIN 1.4401 Stainless Steel

## PIPE CONNECTIONS

Internal thread: Rp, NPT

Flange connection: Tri-clamp, DIN/ANSI/JIS, Vitaulic.

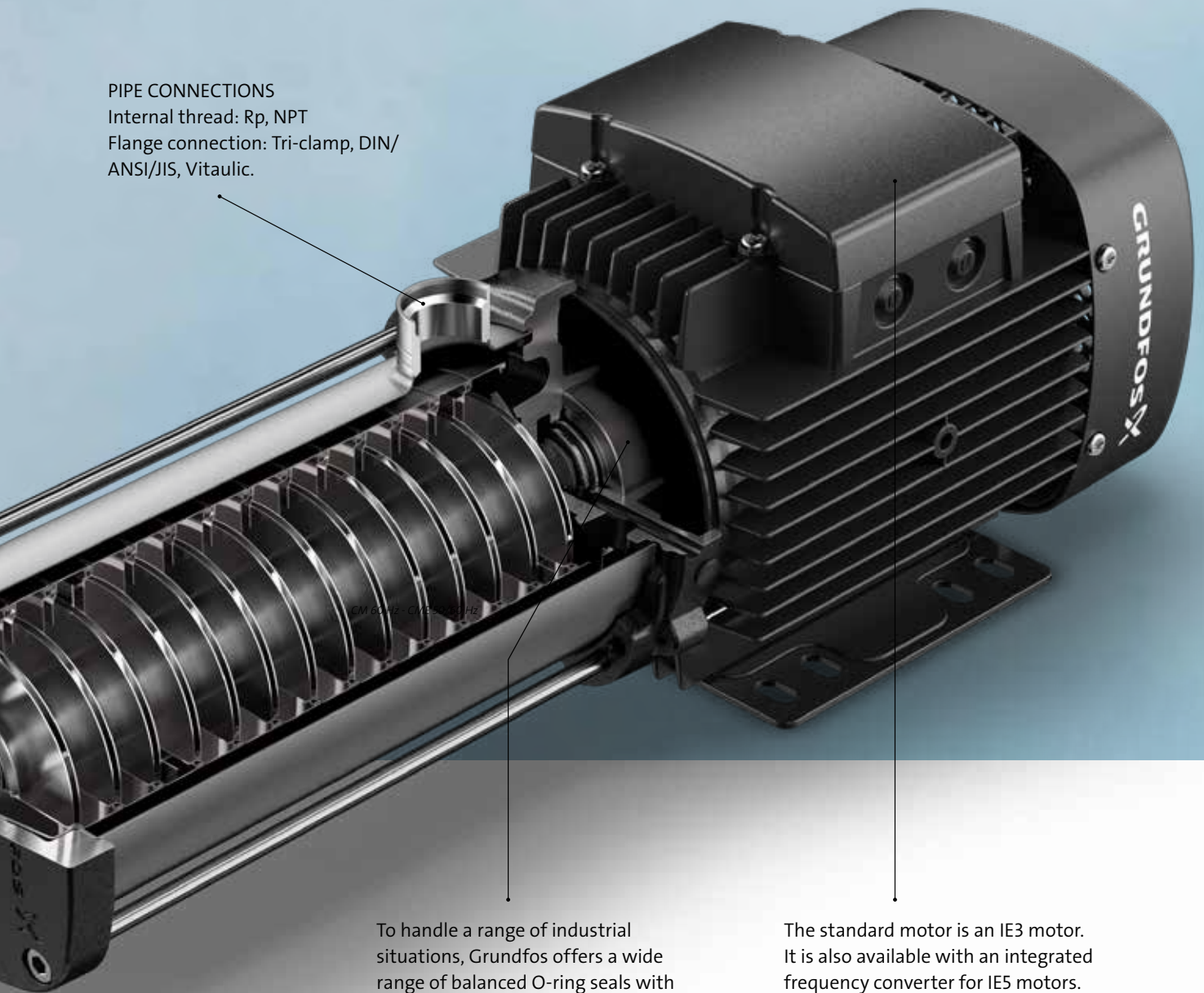

To handle a range of industrial situations, Grundfos offers a wide range of balanced O-ring seals with different seal faces including Silicon Carbide, Carbon, Tungsten Carbide.

Different O-ring materials are also available including EPDM, Viton and Kalrez.

The standard motor is an IE3 motor. It is also available with an integrated frequency converter for IE5 motors. All are available for global voltage with single and three-phase motors.

Motor protection from Klixon, PTC and PT100 or the frequency converter. Enclosure class IP55 as standard.



# SELF-PRIMING PUMPS

## – CREATE POWERFUL SUCTION IN MINUTES

CM pumps now come in a self-priming variant that is fitted with a mains-operated motor and a mechanical shaft seal. Once you have installed and commissioned the pump, the pump can create a suction lift of up to 8 metres in less than 5 minutes, making it ideal for water treatment, domestic pressure boosting, agricultural water supply, and rainwater applications.

The CM selfprimer must be filled with liquid before first use. This fluid is then used to evacuate the air and ensure vacuum is built up.

Unlike non-priming pumps, the CM selfprimer will always have a water reservoir from the first priming, making it better at handling air.



### Self-priming pumps offer:

- Compact design
- Worldwide approvals
- High reliability
- Service-friendly construction
- Wide performance range
- Quiet operation: same sound level as a standard CM pump
- No footvalve required

CM self-priming pumps can function as the main pump in a system or as a feed pump for pumps that require a steady supply of water.

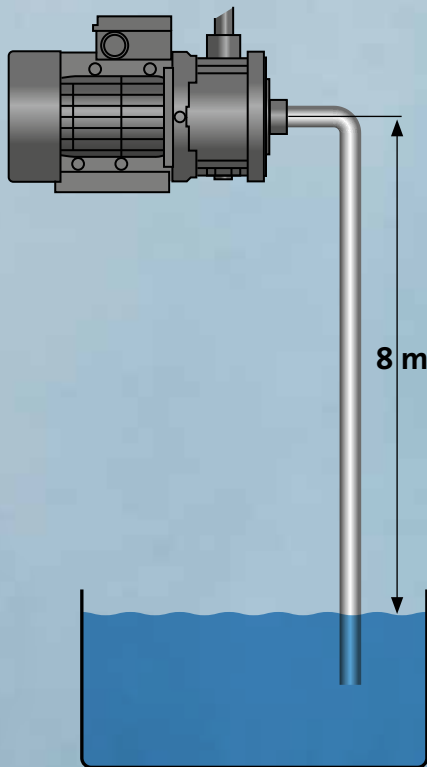

*CM self-priming pumps can create a suction lift up to 8 metres in less than 5 minutes.*

### Customised solutions

The CM self-priming pump is available with all the CM fixed speed motors, all the CM shaft seals, and all flanges.

The pump is available in stainless steel (EN 1.4301/AISI 304).



## CME: INTELLIGENT PERFORMANCE AND OPERATION

CME pumps offer electronic control and energy savings. This all-in-one solution with pump, motor and integrated frequency converter, includes intelligent features that make installation, operation and service exceptionally easy.

CME pumps feature a state-of-the-art energy efficient E drive that meets IE5 standards. The compact CME design is available in all CM sizes.

Like CM pumps, the CME is a multi-purpose pump for both industry and water boosting. It is compact, noiseless, reliable and flexible-making it the ideal solution for installation and interaction with other components in small and large systems, or as a stand-alone pump.



# CM/CME PUMPS: THE **IDEAL SOLUTION** ANYWHERE IN THE WORLD

CM/CME pumps hold global approvals for energy efficiency and safety.

## Energy:

The following energy approvals are available on request:

- Energy Independence and Security Act (EISA) for the USA (CC marking).
- Minimum energy performance standard (MEPS) for Korea, Taiwan, China and Brazil (pending).

## Safety:

- cURus, EAC, CCC, PSE



## HIGH EFFICIENCY **MOTORS**

As standard, the single-speed CM motors are IE3, variable speed motors are IE5.

- **Global approvals**  
Meets current global Minimum Efficiency Performance Standards (MEPS) and approvals applicable in your market, for example cURus for USA and Canada
- **Certificates**  
Certificates for vibration, performance and efficiency levels are available
- **Over or undersize motors**  
For use where the viscosity or density is different from that of water, installations where the altitude exceed 1000 m or where the ambient temperature is very high, Grundfos offers over or undersize motors on the pump
- **Terminal box position**  
The motor can be mounted on the pump head in steps of 90 degrees. (The pump discharge can also be turned)
- **Enclosure class**  
Enclosure class IP55 is standard on CM. Enclosure class IPX4 is available on request
- **Heating units**  
Anti-condensation heating can be supplied by a built-in heating unit
- **Thermal protection**  
Motors with a built-in bimetallic thermal protector (PTO) or a temperature dependent resistor (PTC) are available. Motors from 3 kW and over have PTC as standard. Enclosure class IP55 is standard on CM. Enclosure class IPX4 is available on request.
- **Standard MGE motors**  
(Motors with integrated frequency converters)  
The Grundfos MGE motor with integrated frequency converter can operate at different speeds to optimise pump performance for applications ranging from low speed to over-synchronous speed. Motor protection, pump monitoring, and onboard regulator and sensor supply for control of primary process are built in as standard. To meet specific demands, customised software and add-on hardware can be supplied for special control.



# GRUNDFOS iSOLUTIONS:

## PUMP SYSTEM OPTIMISATION IN TEMPERATURE CONTROL

Keeping efficiency high and costs low in industrial cooling systems requires a control strategy. Grundfos can help you choose a control strategy, drawing on many years in the business and depth of knowledge of cooling systems and electronics.

Pumps in industrial cooling systems often suffer from incorrect control strategies which can lead to inefficient system performance. Furthermore, cooling pumps are often older models that are kept running 24/7.

Grundfos iSOLUTIONS offers a unique set-up that can bring **savings of up to 70%** or more.

The five factors affecting the operating cost of an industrial cooling application can be summarised as follows:

- Pump and motor efficiency
- Regulating mode
- Sizing of system
- Load profile
- Losses in the system

This is where Grundfos iSOLUTIONS comes into play. The approach goes beyond the pump to optimise the entire pumping system. Grundfos works to identify customers' needs and help them avoid situations that will cost them in the long term – for example, by setting up the most intelligent and efficient pump regulation in an industrial cooling application.

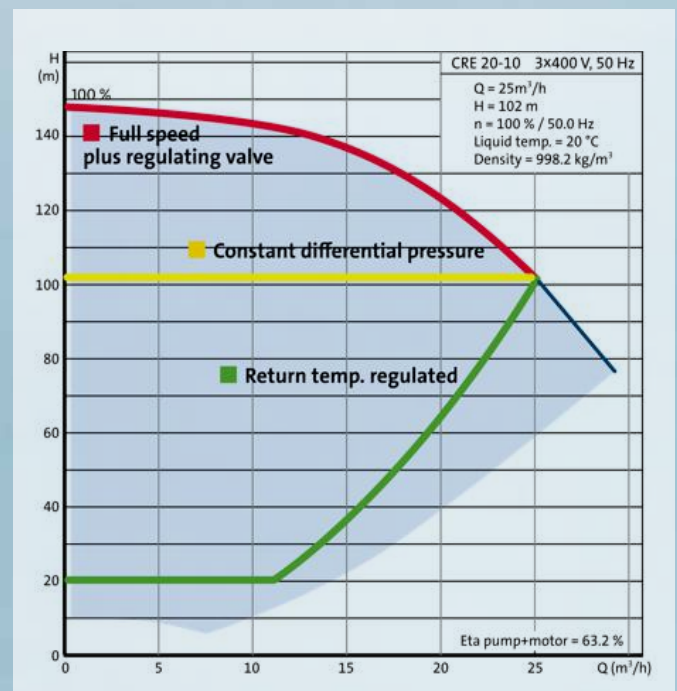

### Power consumption vs. flow

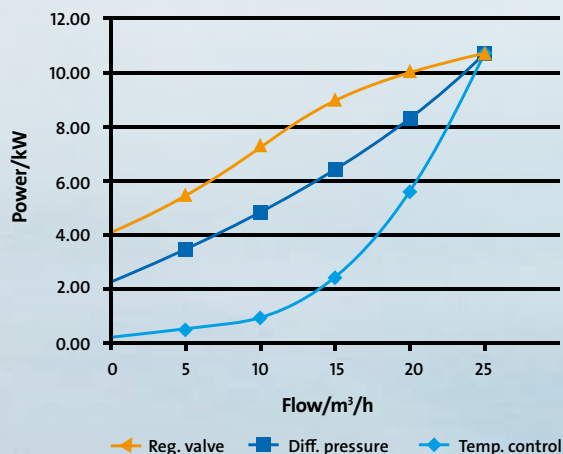

### Three examples of control principles

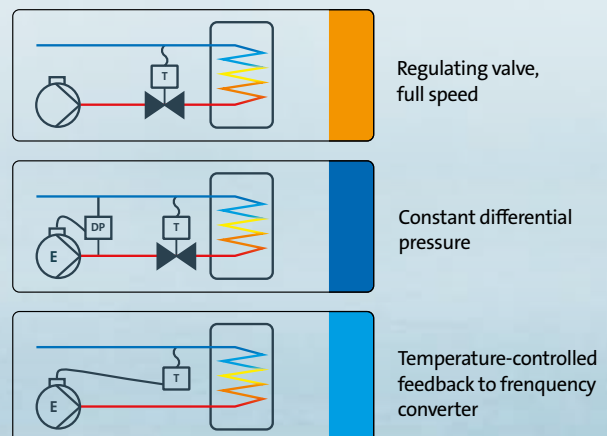

## THE GRUNDFOS CM/CME PUMP

When customisation, modularity, and reliability are key, turn to the new Grundfos CM/CME pump. This horizontal multistage pump is a compact, modular, reliable and quiet pump solution from Grundfos.

The Grundfos CM/CME is designed to be used in a variety of applications including

- Washing and cleaning
- Temperature control
- Water treatment
- Chemical and pharmaceutical industries
- And more...

Three main models are offered with a number of variants available through optional components. These main models are constructed in:

- Cast iron ASTM A48: Class 30B/EN-JL 1030
- AISI304/DIN 1.4301 Stainless Steel
- AISI316/DIN 1.4401 Stainless Steel.